

SX - TC 85 CODE: 0022320.000

SX / EXC-TC/TX - TE 125 CODE: 0022319.000

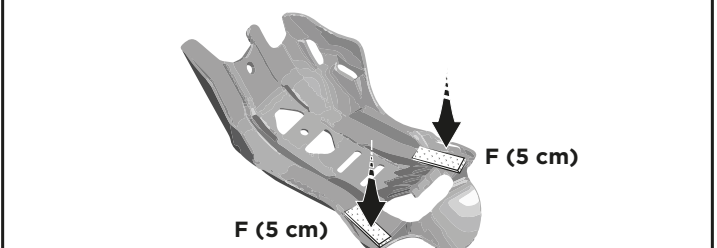

1. Tagliare la spugna ed installarla seguendo misura e posizione indicate.
Cut the sponge to the above measurements and install it in the positions indicated.

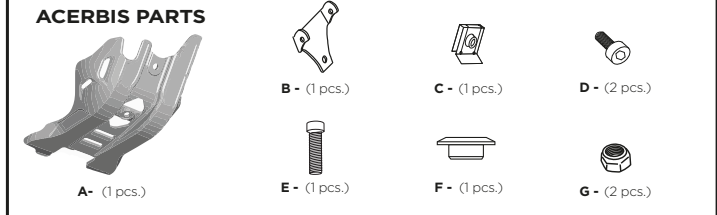
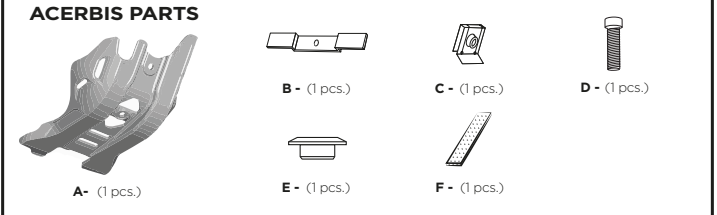
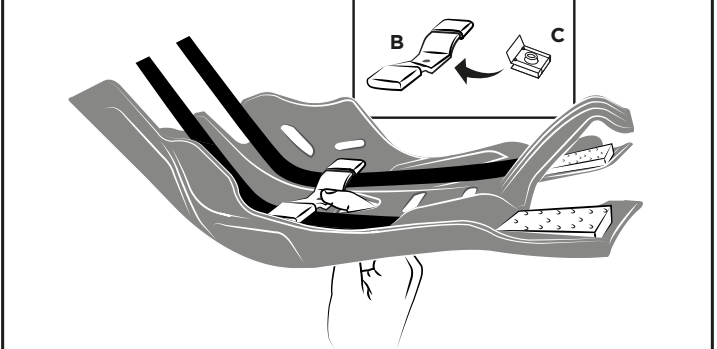

2. Assemblare la clip sulla staffa, posizionare la staffa sul telaio, posizionare il sottomotore sotto il telaio e tenere la staffa con il dito come indicato nel disegno.
Assemble the clip on the bracket, place the bracket on the frame, place the skid-plate under the frame and hold the bracket with your finger as indicated in the sketch.

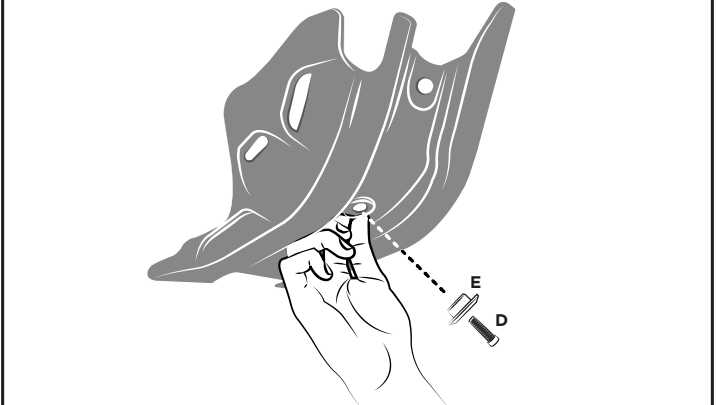

3. Avvitare il sottomotore al telaio tramite la vite in dotazione.
Screw the skid plate to the frame with supplied screw.



1. Scollegare lo scarico e spostarlo avanti per facilitare il montaggio della staffa sul telaio.
Disconnect the exhaust pipe and move it forward to facilitate the mounting of the clamp to the frame.

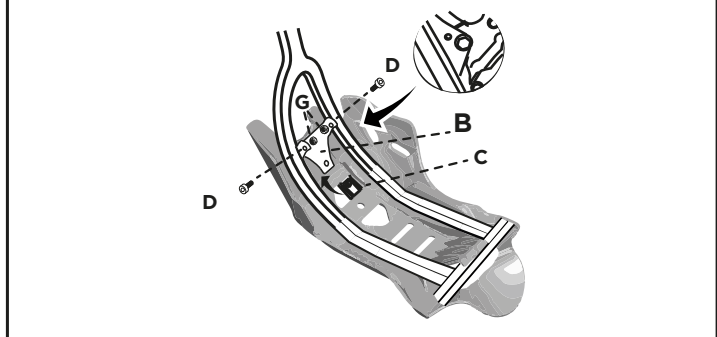

2. Assemblare la clips sulla staffa e fissare la staffa sul telaio come indicato.
Assemble the clip on the clamp and place the clamp on the frame as indicated.

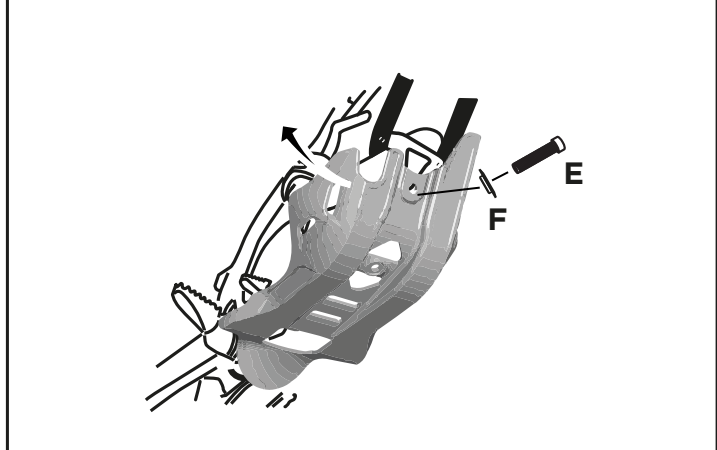

3. Avvitare il sottomotore al telaio.
Screw the skid plate to the frame.

WARNING!
 Use at your own risk. Check the security of your device before you ride. Be sure that you follow the instructions installing the Acerbis products. Do not ride if there is missing or damaged hardware. If this is the case, take the item immediately back to your dealer. Make sure the throttle and other controls are free every time you ride. Lack of attention to instruction and warning could lead to interference with the controls, loss of control, and an accidents. Acerbis recommends that installation must be done by a licensed mechanic and that only Acerbis is original parts are used during fitting. Acerbis makes no guarantees or representations, express or implied, regarding the fitness of its products for any particular purpose. Acerbis makes no guarantees or representations, express or implied, regarding the extent to which its product protect individuals or property from injury or death or damage.